



## Module A: The FreeBSD System

- History
- Design Principles
- Programmer Interface
- User Interface
- Process Management
- Memory Management
- File System
- I/O System
- Interprocess Communication





Operating System Concepts A.1 Silberschatz, Galvin and Gagne ©2002



## History

- First developed in 1969 by Ken Thompson and Dennis Ritchie of the Research Group at Bell Laboratories; incorporated features of other operating systems, especially MULTICS.
- The third version was written in C, which was developed at Bell Labs specifically to support UNIX.
- The most influential of the non-Bell Labs and non-AT&T UNIX development groups — University of California at Berkeley (Berkeley Software Distributions).
  - ◆ 4BSD UNIX resulted from DARPA funding to develop a standard UNIX system for government use.
  - ◆ Developed for the VAX, 4.3BSD is one of the most influential versions, and has been ported to many other platforms.
- Several standardization projects seek to consolidate the variant flavors of UNIX leading to one programming interface to UNIX.



Operating System Concepts A.2 Silberschatz, Galvin and Gagne ©2002

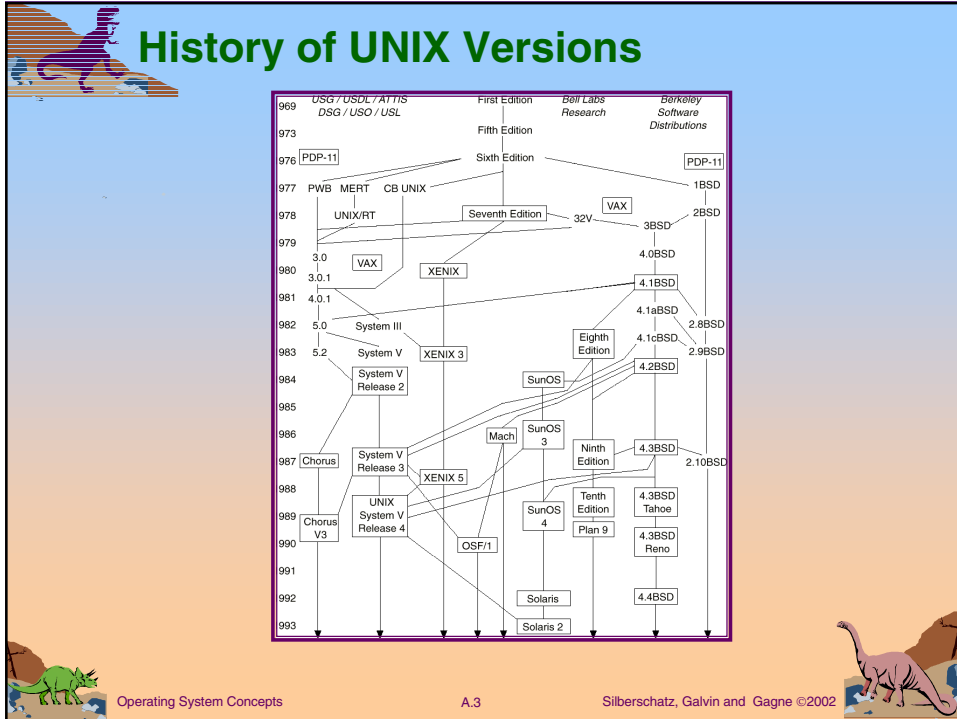

- ## Early Advantages of UNIX
- Written in a high-level language.
  - Distributed in source form.
  - Provided powerful operating-system primitives on an inexpensive platform.
  - Small size, modular, clean design.
- Operating System Concepts A.4 Silberschatz, Galvin and Gagne ©2002



## UNIX Design Principles

- Designed to be a time-sharing system.
- Has a simple standard user interface (shell) that can be replaced.
- File system with multilevel tree-structured directories.
- Files are supported by the kernel as unstructured sequences of bytes.
- Supports multiple processes; a process can easily create new processes.
- High priority given to making system interactive, and providing facilities for program development.



## Programmer Interface

Like most computer systems, UNIX consists of two separable parts:

- Kernel: everything below the system-call interface and above the physical hardware.
  - ✦ Provides file system, CPU scheduling, memory management, and other OS functions through system calls.
- Systems programs: use the kernel-supported system calls to provide useful functions, such as compilation and file manipulation.



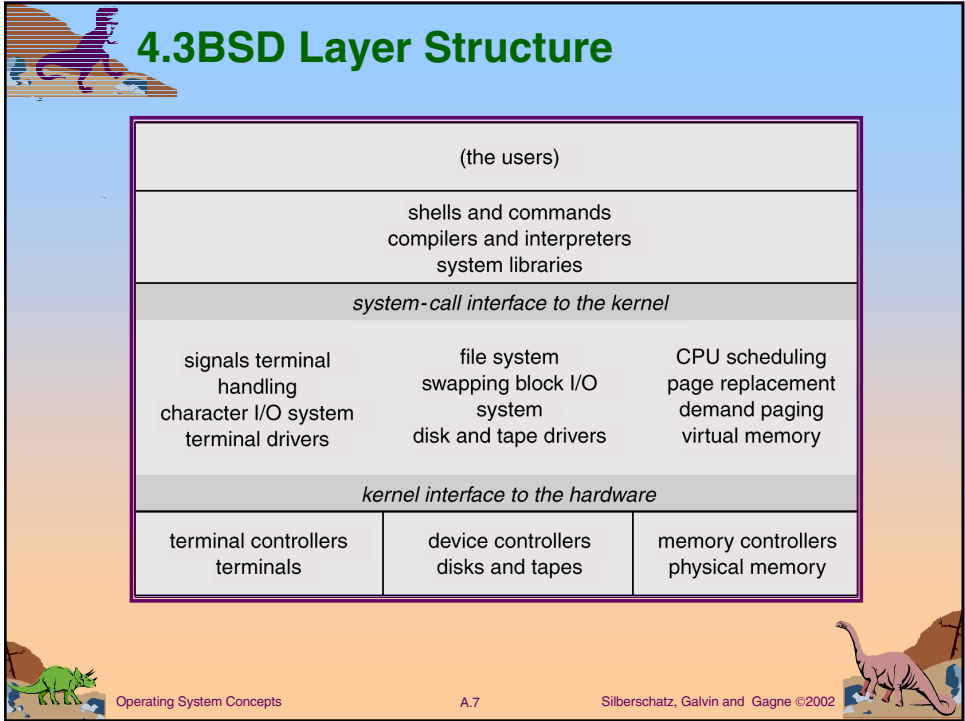

- ## System Calls
- System calls define the programmer interface to UNIX
  - The set of systems programs commonly available defines the user interface.
  - The programmer and user interface define the context that the kernel must support.
  - Roughly three categories of system calls in UNIX.
    - ◆ File manipulation (same system calls also support device manipulation)
    - ◆ Process control
    - ◆ Information manipulation.
- Operating System Concepts
A.8
Silberschatz, Galvin and Gagne ©2002



## File Manipulation

- A *file* is a sequence of bytes; the kernel does not impose a structure on files.
- Files are organized in tree-structured *directories*.
- Directories are files that contain information on how to find other files.
- *Path name*: identifies a file by specifying a path through the directory structure to the file.
  - ◆ Absolute path names start at root of file system
  - ◆ Relative path names start at the current directory
- System calls for basic file manipulation: **create, open, read, write, close, unlink, trunc.**



## Typical UNIX directory structure

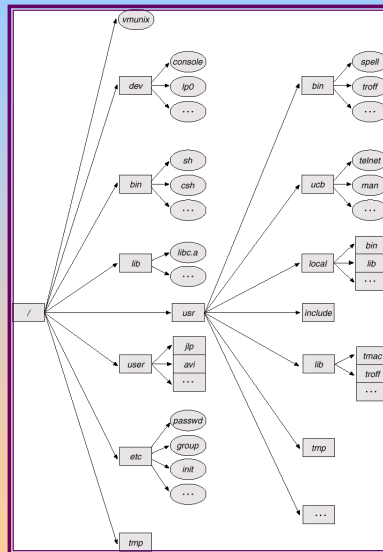

## Process Control

- A process is a program in execution.
- Processes are identified by their process identifier, an integer.
- Process control system calls
  - ✦ **fork** creates a new process
  - ✦ **execve** is used after a fork to replace one of the two processes's virtual memory space with a new program
  - ✦ **exit** terminates a process
  - ✦ A parent may **wait** for a child process to terminate; **wait** provides the process id of a terminated child so that the parent can tell which child terminated.
  - ✦ **wait3** allows the parent to collect performance statistics about the child
- A *zombie* process results when the parent of a *defunct* child process exits before the terminated child.



Operating System Concepts

A.11

Silberschatz, Galvin and Gagne ©2002



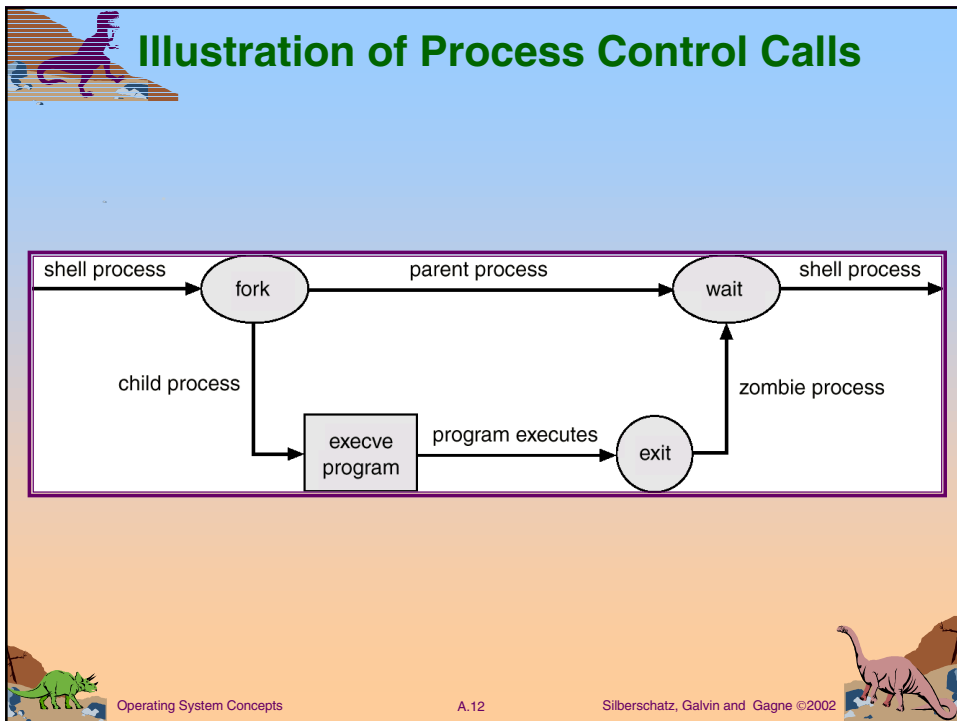



## Process Control (Cont.)

- Processes communicate via pipes; queues of bytes between two processes that are accessed by a file descriptor.
- All user processes are descendants of one original process, *init*.
- *init* forks a *getty* process: initializes terminal line parameters and passes the user's *login name* to *login*.
  - ✦ *login* sets the numeric *user identifier* of the process to that of the user
  - ✦ executes a *shell* which forks subprocesses for user commands.



## Process Control (Cont.)

- **setuid** bit sets the effective user identifier of the process to the user identifier of the owner of the file, and leaves the *real user identifier* as it was.
- **setuid** scheme allows certain processes to have more than ordinary privileges while still being executable by ordinary users.





## Signals

- Facility for handling exceptional conditions similar to software interrupts.
- The *interrupt* signal, SIGINT, is used to stop a command before that command completes (usually produced by ^C).
- Signal use has expanded beyond dealing with exceptional events.
  - ✦ Start and stop subprocesses on demand
  - ✦ SIGWINCH informs a process that the window in which output is being displayed has changed size.
  - ✦ Deliver urgent data from network connections.



## Process Groups

- Set of related processes that cooperate to accomplish a common task.
- Only one process group may use a terminal device for I/O at any time.
  - ✦ The foreground job has the attention of the user on the terminal.
  - ✦ Background jobs – nonattached jobs that perform their function without user interaction.
- Access to the terminal is controlled by process group signals.







## Process Groups (Cont.)

- Each job inherits a controlling terminal from its parent.
  - ✦ If the process group of the controlling terminal matches the group of a process, that process is in the foreground.
  - ✦ SIGTTIN or SIGTTOU freezes a background process that attempts to perform I/O; if the user foregrounds that process, SIGCONT indicates that the process can now perform I/O.
  - ✦ SIGSTOP freezes a foreground process.



## Information Manipulation

- System calls to set and return an interval timer:  
**getitimer/setitimer.**
- Calls to set and return the current time:  
**gettimeofday/settimeofday.**
- Processes can ask for
  - ✦ their process identifier: **getpid**
  - ✦ their group identifier: **getgid**
  - ✦ the name of the machine on which they are executing:  
**gethostname**





## Library Routines

- The system-call interface to UNIX is supported and augmented by a large collection of library routines
- Header files provide the definition of complex data structures used in system calls.
- Additional library support is provided for mathematical functions, network access, data conversion, etc.



## User Interface

- Programmers and users mainly deal with already existing systems programs: the needed system calls are embedded within the program and do not need to be obvious to the user.
- The most common systems programs are file or directory oriented.
  - ◆ Directory: *mkdir*, *rmdir*, *cd*, *pwd*
  - ◆ File: *ls*, *cp*, *mv*, *rm*
- Other programs relate to editors (e.g., *emacs*, *vi*) text formatters (e.g., *troff*, *TEX*), and other activities.





## Shells and Commands

- *Shell* – the user process which executes programs (also called command interpreter).
- Called a shell, because it surrounds the kernel.
- The shell indicates its readiness to accept another command by typing a prompt, and the user types a command on a single line.
- A typical command is an executable binary object file.
- The shell travels through the *search path* to find the command file, which is then loaded and executed.
- The directories `/bin` and `/usr/bin` are almost always in the search path.



## Shells and Commands (Cont.)

- Typical search path on a BSD system:

( `./home/prof/avi/bin /usr/local/bin  
/usr/ucb/bin/usr/bin` )



- The shell usually suspends its own execution until the command completes.





## Standard I/O

- Most processes expect three file descriptors to be open when they start:
  - ✦ *standard input* – program can read what the user types
  - ✦ *standard output* – program can send output to user's screen
  - ✦ *standard error* – error output
- Most programs can also accept a file (rather than a terminal) for standard input and standard output.
- The common shells have a simple syntax for changing what files are open for the standard I/O streams of a process — *I/O redirection*.





Operating System Concepts A.23 Silberschatz, Galvin and Gagne ©2002



## Standard I/O Redirection

Command	Meaning of command
% ls > filea	direct output of <i>ls</i> to file <i>filea</i>
% pr < filea > fileb	input from <i>filea</i> and output to <i>fileb</i>
% lpr < fileb	input from <i>fileb</i>
%% make program > & errs	save both standard output and standard error in a file

Operating System Concepts A.24 Silberschatz, Galvin and Gagne ©2002



## Pipelines, Filters, and Shell Scripts

- Can coalesce individual commands via a vertical bar that tells the shell to pass the previous command's output as input to the following command

```
% ls | pr | lpr
```



- Filter – a command such as `pr` that passes its standard input to its standard output, performing some processing on it.
- Writing a new shell with a different syntax and semantics would change the user view, but not change the kernel or programmer interface.
- X Window System is a widely accepted iconic interface for UNIX.



Operating System Concepts

A.25

Silberschatz, Galvin and Gagne ©2002



## Process Management

- Representation of processes is a major design problem for operating system.
- UNIX is distinct from other systems in that multiple processes can be created and manipulated with ease.
- These processes are represented in UNIX by various control blocks.
  - ✦ Control blocks associated with a process are stored in the kernel.
  - ✦ Information in these control blocks is used by the kernel for process control and CPU scheduling.



Operating System Concepts

A.26

Silberschatz, Galvin and Gagne ©2002





## Process Control Blocks

- The most basic data structure associated with processes is the *process structure*.
  - ◆ unique process identifier
  - ◆ scheduling information (e.g., priority)
  - ◆ pointers to other control blocks
- The *virtual address space* of a user process is divided into text (program code), data, and stack segments.
- Every process with sharable text has a pointer from its process structure to a *text structure*.
  - ◆ always resident in main memory.
  - ◆ records how many processes are using the text segment
  - ◆ records where the page table for the text segment can be found on disk when it is swapped.



## System Data Segment

- Most ordinary work is done in *user mode*; system calls are performed in *system mode*.
- The system and user phases of a process never execute simultaneously.
- a *kernel stack* (rather than the user stack) is used for a process executing in system mode.
- The kernel stack and the user structure together compose the *system data* segment for the process.



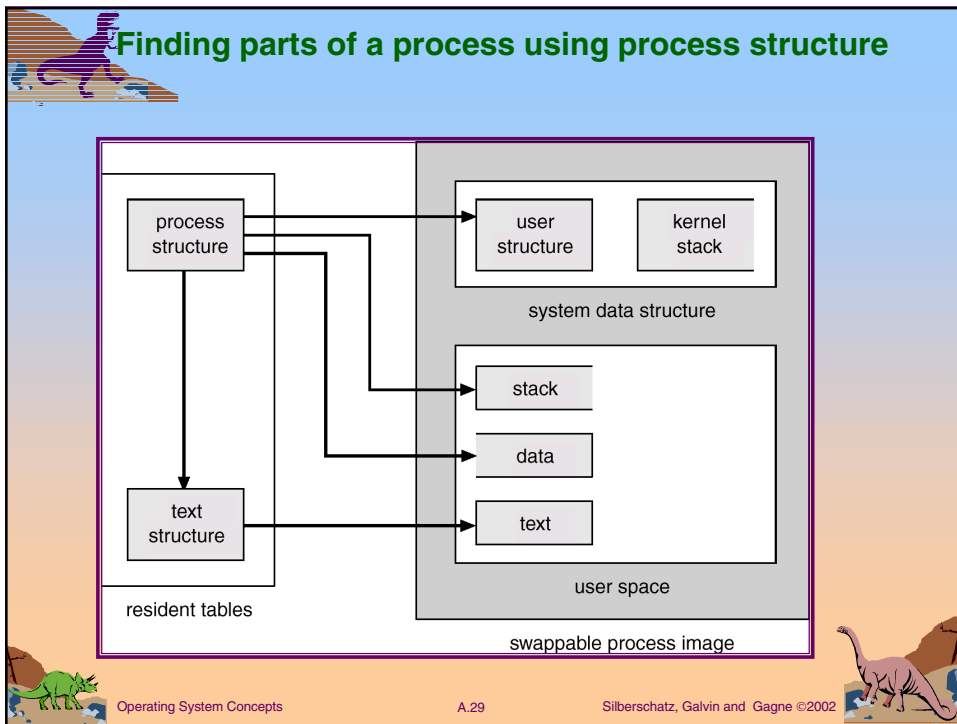

- ## Allocating a New Process Structure
- **fork** allocates a new process structure for the child process, and copies the user structure.
    - ◆ new page table is constructed
    - ◆ new main memory is allocated for the data and stack segments of the child process
    - ◆ copying the user structure preserves open file descriptors, user and group identifiers, signal handling, etc.
- Operating System Concepts A.30 Silberschatz, Galvin and Gagne ©2002



## Allocating a New Process Structure (Cont.)

- **vfork** does *not* copy the data and stack to the new process; the new process simply shares the page table of the old one.
  - ◆ new user structure and a new process structure are still created
  - ◆ commonly used by a shell to execute a command and to wait for its completion
- A parent process uses **vfork** to produce a child process; the child uses **execve** to change its virtual address space, so there is no need for a copy of the parent.
- Using **vfork** with a large parent process saves CPU time, but can be dangerous since any memory change occurs in both processes until **execve** occurs.
- **execve** creates no new process or user structure; rather the text and data of the process are replaced.



## CPU Scheduling

- Every process has a *scheduling priority* associated with it; larger numbers indicate lower priority.
- Negative feedback in CPU scheduling makes it difficult for a single process to take all the CPU time.
- Process aging is employed to prevent starvation.
- When a process chooses to relinquish the CPU, it goes to *sleep* on an *event*.
- When that event occurs, the system process that knows about it calls *wakeup* with the address corresponding to the event, and *all* processes that had done a *sleep* on the same address are put in the ready queue to be run.







## Memory Management

- The initial memory management schemes were constrained in size by the relatively small memory resources of the PDP machines on which UNIX was developed.
- Pre 3BSD system use swapping exclusively to handle memory contention among processes: If there is too much contention, processes are swapped out until enough memory is available.
- Allocation of both main memory and swap space is done first-fit.



## Memory Management (Cont.)

- Sharable text segments do not need to be swapped; results in less swap traffic and reduces the amount of main memory required for multiple processes using the same text segment.
- The *scheduler process* (or *swapper*) decides which processes to swap in or out, considering such factors as time idle, time in or out of main memory, size, etc.
- In f.3BSD, swap space is allocated in pieces that are multiples of power of 2 and minimum size, up to a maximum size determined by the size of the swap-space partition on the disk.





## Paging

- Berkeley UNIX systems depend primarily on paging for memory-contention management, and depend only secondarily on swapping.
- *Demand paging* – When a process needs a page and the page is not there, a page fault to the kernel occurs, a frame of main memory is allocated, and the proper disk page is read into the frame.
- A *pagedaemon* process uses a modified second-chance page-replacement algorithm to keep enough free frames to support the executing processes.
- If the scheduler decides that the paging system is overloaded, processes will be swapped out whole until the overload is relieved.



## File System

- The UNIX file system supports two main objects: files and directories.
- Directories are just files with a special format, so the representation of a file is the basic UNIX concept.





## Blocks and Fragments

- Most of the file system is taken up by *data blocks*.
- 4.2BSD uses *two* block sizes for files which have no indirect blocks:
  - ◆ All the blocks of a file are of a large *block size* (such as 8K), except the last.
  - ◆ The last block is an appropriate multiple of a smaller *fragment size* (i.e., 1024) to fill out the file.
  - ◆ Thus, a file of size 18,000 bytes would have two 8K blocks and one 2K fragment (which would not be filled completely).



## Blocks and Fragments (Cont.)

- The *block* and *fragment* sizes are set during file-system creation according to the intended use of the file system:
  - ◆ If many small files are expected, the fragment size should be small.
  - ◆ If repeated transfers of large files are expected, the basic block size should be large.
- The maximum block-to-fragment ratio is 8 : 1; the minimum block size is 4K (typical choices are 4096 : 512 and 8192 : 1024).





## Inodes

- A file is represented by an *inode* — a record that stores information about a specific file on the disk.
- The inode also contains 15 pointer to the disk blocks containing the file's data contents.
  - ◆ First 12 point to *direct blocks*.
  - ◆ Next three point to *indirect blocks*
    - ✓ First indirect block pointer is the address of a *single indirect block* — an index block containing the addresses of blocks that do contain data.
    - ✓ Second is a *double-indirect-block pointer*, the address of a block that contains the addresses of blocks that contain pointer to the actual data blocks.
    - ✓ A *triple indirect* pointer is not needed; files with as many as 232 bytes will use only double indirection.



## Directories

- The inode type field distinguishes between plain files and directories.
- Directory entries are of variable length; each entry contains first the length of the entry, then the file name and the inode number.
- The user refers to a file by a path name, whereas the file system uses the inode as its definition of a file.
  - ◆ The kernel has to map the supplied user path name to an inode
  - ◆ Directories are used for this mapping.





## Directories (Cont.)

- First determine the starting directory:
  - ◆ If the first character is “/”, the starting directory is the root directory.
  - ◆ For any other starting character, the starting directory is the current directory.
- The search process continues until the end of the path name is reached and the desired inode is returned.
- Once the inode is found, a file structure is allocated to point to the inode.
- 4.3BSD improved file system performance by adding a directory name cache to hold recent directory-to-inode translations.



## Mapping of a File Descriptor to an Inode

- System calls that refer to open files indicate the file is passing a file descriptor as an argument.
- The file descriptor is used by the kernel to index a table of open files for the current process.
- Each entry of the table contains a pointer to a file structure.
- This file structure in turn points to the inode.
- Since the open file table has a fixed length which is only settable at boot time, there is a fixed limit on the number of concurrently open files in a system.



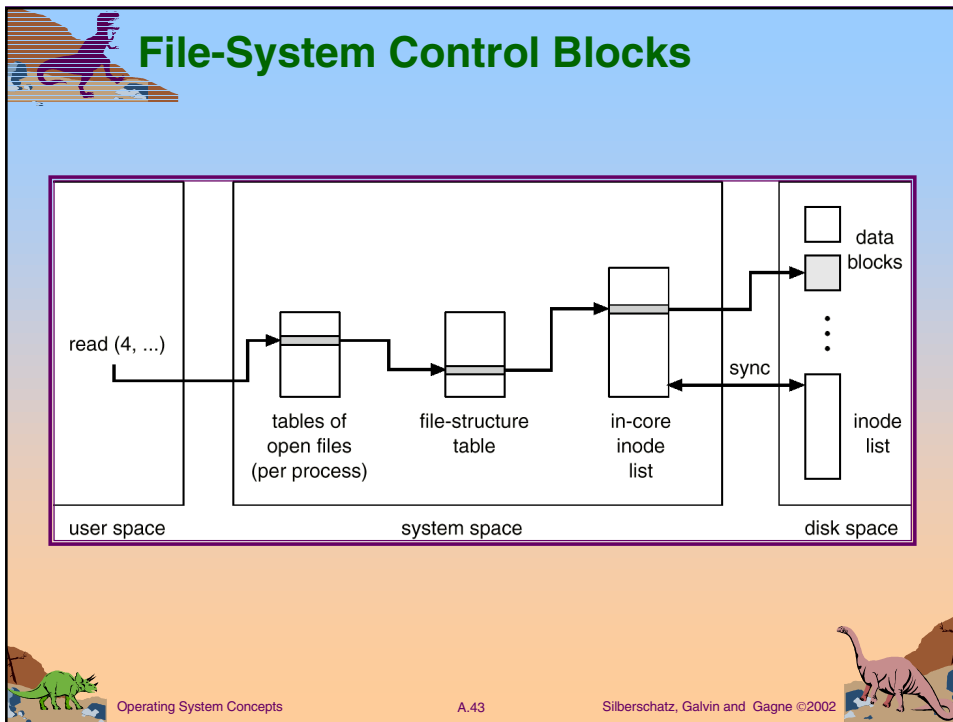

- ## Disk Structures
- The one file system that a user ordinarily sees may actually consist of several physical file systems, each on a different device.
  - Partitioning a physical device into multiple file systems has several benefits.
    - ✦ Different file systems can support different uses.
    - ✦ Reliability is improved
    - ✦ Can improve efficiency by varying file-system parameters.
    - ✦ Prevents one program from using all available space for a large file.
    - ✦ Speeds up searches on backup tapes and restoring partitions from tape.
- Decorative elements include a purple dinosaur in the top left and a pink dinosaur in the bottom right.
- Operating System Concepts A.44 Silberschatz, Galvin and Gagne ©2002

## Disk Structures (Cont.)

- The *root file system* is always available on a drive.
- Other file systems may be *mounted* — i.e., integrated into the directory hierarchy of the root file system.
- The following figure illustrates how a directory structure is partitioned into file systems, which are mapped onto logical devices, which are partitions of physical devices.

Operating System Concepts
A.45
Silberschatz, Galvin and Gagne ©2002

## Mapping File System to Physical Devices

The diagram illustrates the mapping process from a logical file system to physical devices. On the left, a large tree structure represents the **logical file system**. This is partitioned into several smaller trees representing **file systems**. These file systems are then mapped to **logical devices**, which are represented by small cylinders. Finally, these logical devices are mapped to **physical devices**, which are represented by larger cylinders. The physical devices are shown with partitions labeled **root** and **swap**.

Operating System Concepts
A.46
Silberschatz, Galvin and Gagne ©2002



## Implementations

- The user interface to the file system is simple and well defined, allowing the implementation of the file system itself to be changed without significant effect on the user.
- For Version 7, the size of inodes doubled, the maximum file and file system sized increased, and the details of free-list handling and superblock information changed.
- In 4.0BSD, the size of blocks used in the file system was increased from 512 bytes to 1024 bytes — increased internal fragmentation, but doubled throughput.
- 4.2BSD added the Berkeley Fast File System, which increased speed, and included new features.
  - ◆ New directory system calls
  - ◆ **truncate** calls
  - ◆ Fast File System found in most implementations of UNIX.



## Layout and Allocation Policy

- The kernel uses a *<logical device number, inode number>* pair to identify a file.
  - ◆ The logical device number defines the file system involved.
  - ◆ The inodes in the file system are numbered in sequence.
- 4.3BSD introduced the *cylinder group* — allows localization of the blocks in a file.
  - ◆ Each cylinder group occupies one or more consecutive cylinders of the disk, so that disk accesses within the cylinder group require minimal disk head movement.
  - ◆ Every cylinder group has a superblock, a cylinder block, an array of inodes, and some data blocks.





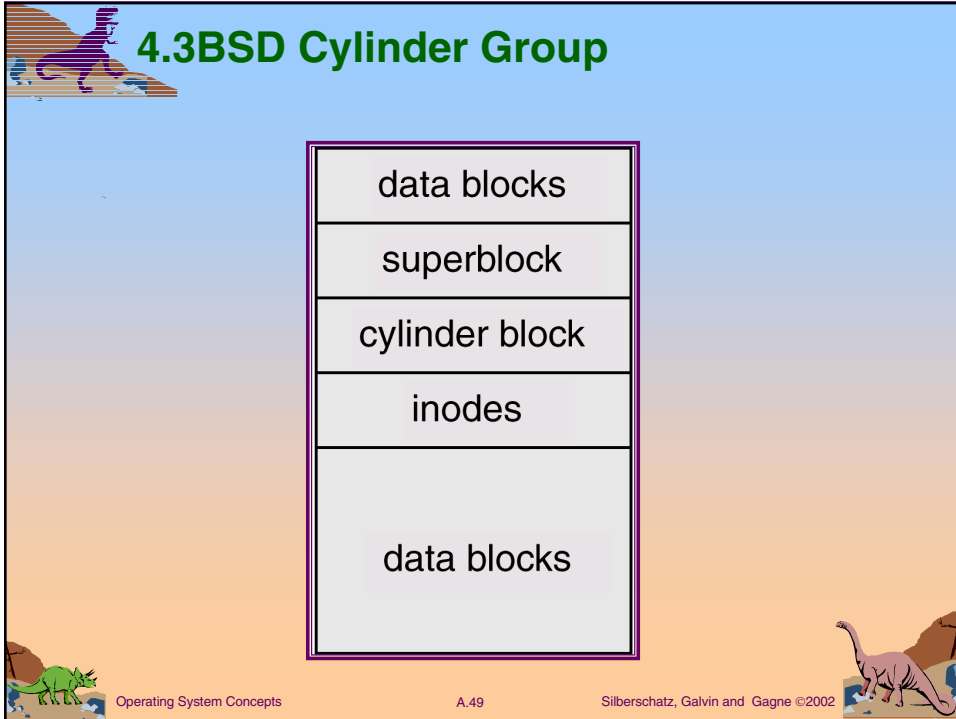

## I/O System

- The I/O system hides the peculiarities of I/O devices from the bulk of the kernel.
- Consists of a buffer caching system, general device driver code, and drivers for specific hardware devices.
- Only the device driver knows the peculiarities of a specific device.

Operating System Concepts

A.50

Silberschatz, Galvin and Gagne ©2002

## 4.3 BSD Kernel I/O Structure

<i>system-call interface to the kernel</i>					
socket	plain file	cooked block interface	raw block interface	raw tty interface	cooked TTY
protocols	file system				line discipline
network interface	block-device driver		character-device driver		
<i>the hardware</i>					

Operating System Concepts
A.51
Silberschatz, Galvin and Gagne ©2002

## Block Buffer Cache

- Consist of buffer headers, each of which can point to a piece of physical memory, as well as to a device number and a block number on the device.
- The buffer headers for blocks not currently in use are kept in several linked lists:
  - ✦ Buffers recently used, linked in LRU order (LRU list).
  - ✦ Buffers not recently used, or without valid contents (AGE list).
  - ✦ EMPTY buffers with no associated physical memory.
- When a block is wanted from a device, the cache is searched.
- If the block is found it is used, and no I/O transfer is necessary.
- If it is not found, a buffer is chosen from the AGE list, or the LRU list if AGE is empty.

Operating System Concepts
A.52
Silberschatz, Galvin and Gagne ©2002



## Block Buffer Cache (Cont.)

- Buffer cache size effects system performance; if it is large enough, the percentage of cache hits can be high and the number of actual I/O transfers low.
- Data written to a disk file are buffered in the cache, and the disk driver sorts its output queue according to disk address — these actions allow the disk driver to minimize disk head seeks and to write data at times optimized for disk rotation.



## Raw Device Interfaces

- Almost every block device has a character interface, or *raw device interface* — unlike the block interface, it bypasses the block buffer cache.
- Each disk driver maintains a queue of pending transfers.
- Each record in the queue specifies:
  - ◆ whether it is a read or a write
  - ◆ a main memory address for the transfer
  - ◆ a device address for the transfer
  - ◆ a transfer size
- It is simple to map the information from a block buffer to what is required for this queue.





## C-Lists

- Terminal drivers use a character buffering system which involves keeping small blocks of characters in linked lists.
- A **write** system call to a terminal enqueues characters on a list for the device. An initial transfer is started, and interrupts cause dequeuing of characters and further transfers.
- Input is similarly interrupt driven.
- It is also possible to have the device driver bypass the canonical queue and return characters directly from the raw queue — *raw mode* (used by full-screen editors and other programs that need to react to every keystroke).



## Interprocess Communication



- Most UNIX systems have not permitted *shared memory* because the PDP-11 hardware did not encourage it.
- The *pipe* is the IPC mechanism most characteristic of UNIX.
  - ✦ Permits a reliable unidirectional byte stream between two processes.
  - ✦ A benefit of pipes small size is that pipe data are seldom written to disk; they usually are kept in memory by the normal block buffer cache.
- In 4.3BSD, pipes are implemented as a special case of the *socket* mechanism which provides a general interface not only to facilities such as pipes, which are local to one machine, but also to networking facilities.
- The socket mechanism can be used by unrelated processes.





## Sockets

- A socket is an endpoint of communication.
- An in-use socket is usually bound with an address; the nature of the address depends on the *communication domain* of the socket.
- A characteristic property of a domain is that processes communicating in the same domain use the same *address format*.
- A single socket can communicate in only one domain — the three domains currently implemented in 4.3BSD are:
  - ◆ the UNIX domain (AF\_UNIX)
  - ◆ the Internet domain (AF\_INET)
  - ◆ the XEROX Network Service (NS) domain (AF\_NS)





Operating System Concepts A.57 Silberschatz, Galvin and Gagne ©2002



## Socket Types

- **Stream sockets** provide reliable, duplex, sequenced data streams. Supported in Internet domain by the TCP protocol. In UNIX domain, pipes are implemented as a pair of communicating stream sockets.
- **Sequenced packet sockets** provide similar data streams, except that record boundaries are provided. Used in XEROX AF\_NS protocol.
- **Datagram sockets** transfer messages of variable size in either direction. Supported in Internet domain by UDP protocol.
- **Reliably delivered message sockets** transfer messages that are guaranteed to arrive. Currently unsupported.
- **Raw sockets** allow direct access by processes to the protocols that support the other socket types; e.g., in the Internet domain, it is possible to reach TCP, IP beneath that, or a deeper Ethernet protocol. Useful for developing new protocols.



Operating System Concepts A.58 Silberschatz, Galvin and Gagne ©2002



## Socket System Calls



- The **socket** call creates a socket; takes as arguments specifications of the communication domain, socket type, and protocol to be used and returns a small integer called a *socket descriptor*.
- A name is bound to a socket by the **bind** system call.
- The **connect** system call is used to initiate a connection.
- A server process uses **socket** to create a socket and **bind** to bind the well-known address of its service to that socket.
  - ◆ Uses **listen** to tell the kernel that it is ready to accept connections from clients.
  - ◆ Uses **accept** to accept individual connections.
  - ◆ Uses **fork** to produce a new process after the **accept** to service the client while the original server process continues to listen for more connections.



Operating System Concepts

A.59

Silberschatz, Galvin and Gagne ©2002



## Socket System Calls (Cont.)

- The simplest way to terminate a connection and to destroy the associated socket is to use the **close** system call on its socket descriptor.
- The **select** system call can be used to multiplex data transfers on several file descriptors and /or socket descriptors



Operating System Concepts

A.60

Silberschatz, Galvin and Gagne ©2002





# Network Support

- Networking support is one of the most important features in 4.3BSD.
- The socket concept provides the programming mechanism to access other processes, even across a network.
- Sockets provide an interface to several sets of protocols.
- Almost all current UNIX systems support UUCP.
- 4.3BSD supports the DARPA Internet protocols UDP, TCP, IP, and ICMP on a wide range of Ethernet, token-ring, and ARPANET interfaces.
- The 4.3BSD networking implementation, and to a certain extent the socket facility, is more oriented toward the ARPANET Reference Model (ARM).



# Network Reference models and Layering

ISO reference model	ARPANET reference model	4.2BSD layers	example layering
application	process applications	user programs and libraries	telnet
presentation			sock_stream
session		host-to-host	protocol
transport	IP		
network data link	network interface	network interfaces	Ethernet driver
hardware			network hardware

